

THIS INFORMATION IS CONFIDENTIAL
 AND IS NOT TO BE DISCLOSED WITHOUT WRITTEN AUTHORIZATION
 FROM HENDOR POMPEN B.V. BLADEL.

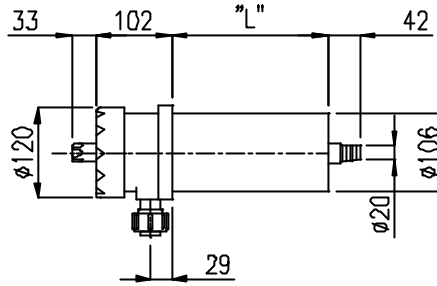

"L"
 FIT-11Z-K-PP (10") 210
 FIT-12Z-K-PP (20") 464

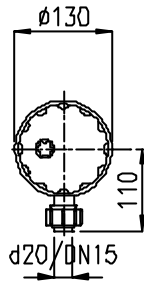
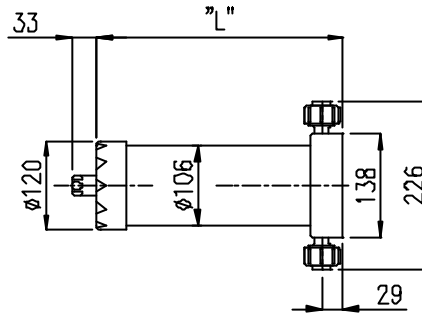
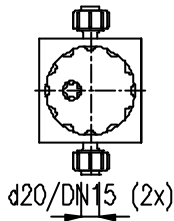

"L"
 F-11H-K-PP (10") 331
 F-12H-K-PP (20") 585

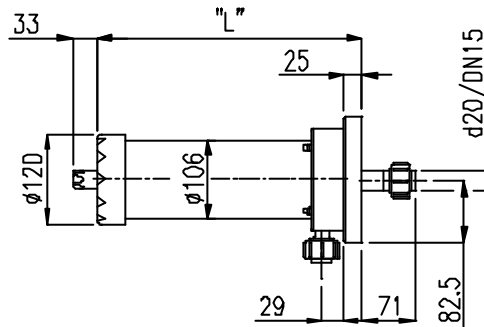
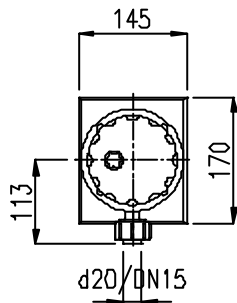

"L"
 F-11Z-K-PP (10") 356
 F-12Z-K-PP (20") 610

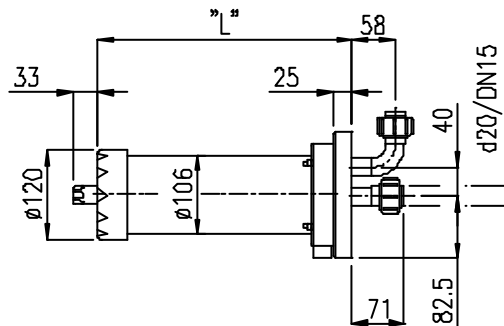
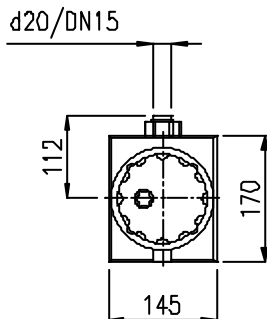

"L"
 F-11A-K-PP (10") 341
 F-12A-K-PP (20") 595

material	PP	drw.	H. Goorman	scale	1 : 10
mat. size	All sizes in mm	date	03-02-2003	Man 3.2/	
		chk.			
Chk.	Date	No.	FILTERCHAMBER F(IT)-11/12A/H/Z-K-PP		

www.hendor.com

Overall tolerance $\pm 1\text{mm}$ Angle tolerances $\Delta \pm 1^\circ$

drw. no.	000-001-710	size	A4
File no.	0-001710		